

## Installation and Maintenance Instructions

1. ADIR Semi-Automatic disc filters model **TDS** ..... Pg.2-17
2. ADIR Semi – Automatic Disc filters battery model **TDSB** .....Pg. 18-19

## TDS Semi-Automatic disc filters

### Table of contents

|   |        |
|---|--------|
| • TDS technical information                                   | Pg. 3  |
| • TDS 3" 1 action – Installation and maintenance instructions | Pg. 4  |
| • TDS 2" 1 action – Installation and maintenance instructions | Pg. 6  |
| • TDS 1 action filters- Periodic maintenance                  | Pg. 8  |
| • TDS 3" 2 action – Installation and maintenance instructions | Pg. 9  |
| • TDS 2" 2 action – Installation and maintenance instructions | Pg. 11 |
| • TDS 2 action filters- Periodic maintenance                  | Pg. 13 |
| • Trouble shooting all models                                 | Pg. 14 |
| • Proper flushing of Discs                                    | Pg. 15 |

## Technical Specifications

- Available size: 2-3"
- Max. working pressure: 10 bar.
- Max. flow rate:
  - 2" - 25 m<sup>3</sup>/h
  - 3" - 40 m<sup>3</sup>/h
- Available in 20-425 micron (700-40 mesh)
- Flushing flow rate:
  - 2 bar – 9.0 m<sup>3</sup>/h
  - 3 bar - 12 m<sup>3</sup>/h
- Filtration area: 1025 cm<sup>2</sup>
- Construction materials:
  - PA+ GF, PP, PP+GF.
  - O rings: EPDM
- Weight (empty): 9.3 Kg.

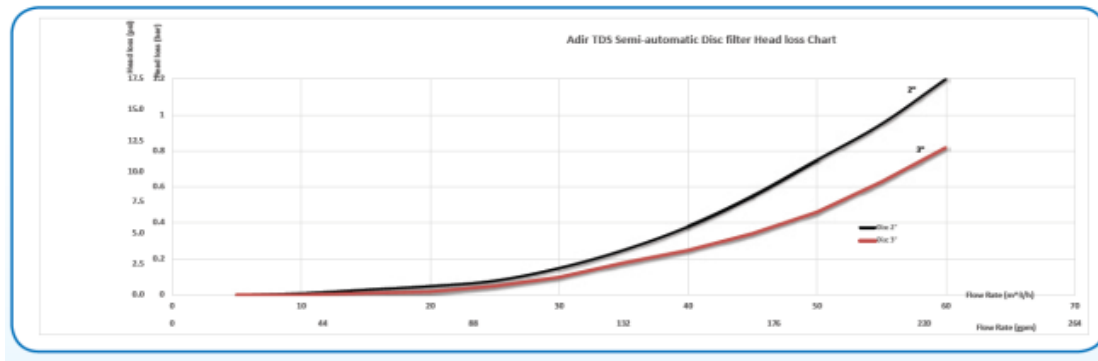

## **ADIR Semi-Automatic 3" filter TDS – Gen2** **Installation and maintenance instructions 1 action**

### **Box contents**

- Main filter assembled – picture A
- Valve F/F 1/2" and Nipple M/M 1/2" – picture B
- Pressure indicator kit and fittings – picture C
  - Pressure indicator (Picture C-3).
  - Tube 6 mm length 25 cm (Picture C-4).
  - Tube 6 mm length 20 cm (Picture C-5).
  - Threaded couplers 1/4"F x 2 (Picture C-6)
  - Connectors 1/4"M to 6 mm elbow x 2 (Picture C-7).
  - Connector 1/4"F to 6 mm elbow (Picture C-8).
  - Connector 1/4"F to 6 mm adaptor (Picture C-9).

### **Assembly**

- Connect the valve 1/2" with nipple 1/2" to the flush port outlet (no need to use Teflon, valve is self-seal) – (Picture B).
- Pressure indicator kit assembly:
  - Connect two threaded couplers 1/4"F to filter body top 1/4" outlets.
  - Connect two 1/4"M to 6 mm elbow to the threaded couplers 1/4"F.
  - Connect 1/4"F to 6 mm elbow to the bottom of the indicator (upstream - high pressure).
  - Connect 1/4"F to 6 mm adaptor to side of the indicator (downstream – low pressure).
  - Press fit the indicator to the sockets on the filter body.
  - Connect 6 mm tube length 25cm from Filter inlet port to indicator bottom (marked "+").
  - Connect 6 mm tube length 20 cm from Filter outlet port to indicator side (marked "-").
  - Hydraulic fittings may require Teflon to seal.
- Filter is ready for installation (Picture D)

### **Installation**

- Filter can be installed in vertical position or at 90° to the pipe, (Bottom of the cup pointing down or to the side).
- Ensure proper flow direction as clearly marked on the filter.
- Make sure valve 1/2" is closed.
- It is recommended to install a shut off inlet valve before the filter for maintenance.
- Filter is ready for first operation.



Picture A  
Before  
assembly

Picture D  
After  
assembly

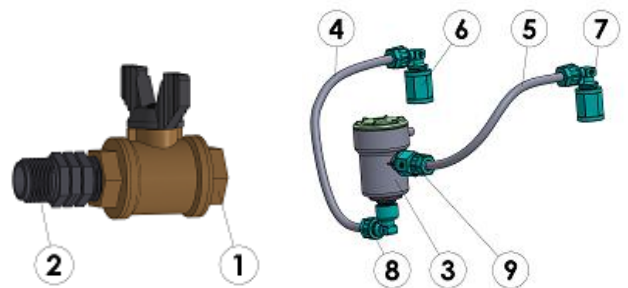

Picture B

Picture C

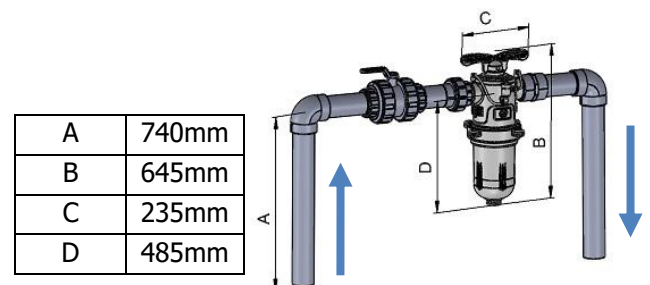

## First Operation

- Open the water source and inlet maintenance valve and check for leaks.
- Perform 2-3 flushing cycles as outlined below.
- Filter is ready for use.

## Flushing the filter

- The disc element needs to be cleaned when the head loss across the filter reaches 0.5-0.7 bar and the red pin is pushed out from the pressure indicator (Picture E).
- Turn the handle  $\frac{1}{4}$ + of a turn until the stop (Picture F).
- Wait 15–30 seconds.
- Turn the filter handle back (Picture F).
- Open the valve  $\frac{1}{2}$ " for 10 seconds and close (Picture G).

**Please note:** the strength required to turn the handle may vary according to water pressure, the water quality and its source.

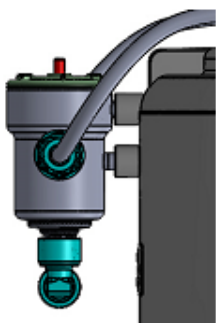

Picture E

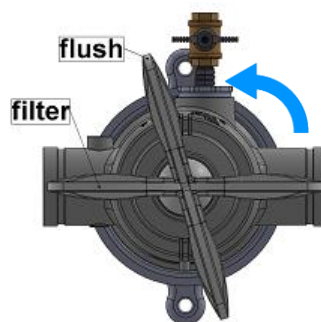

Picture F

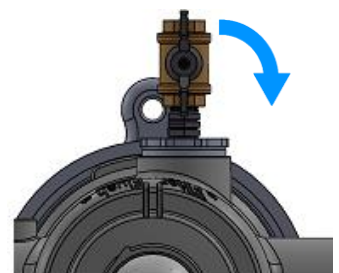

Picture G

## **ADIR Semi-Automatic 2" filter TDS – Gen2** **Installation and maintenance instructions 1 action**

### **Box contents**

- Main filter assembled – picture A
- Valve F/F 1/2" and Nipple M/M 1/2" – picture B
- Pressure indicator kit and fittings – picture C
  - Pressure indicator (Picture C-3).
  - Tube 6 mm length 25 cm (Picture C-4).
  - Tube 6 mm length 20 cm (Picture C-5).
  - Connector 1/4"F to 6 mm adaptor x 2 (Picture C-6)
  - Connector 1/4"F to 6 mm elbow (Picture C-7).
  - Connector 1/4"F to 6 mm adaptor (Picture C-8).

### **Assembly**

- Connect the valve 1/2" with nipple 1/2" to the flush port outlet (no need to use Teflon, valve is self-seal) – (Picture B).
- Pressure indicator kit assembly:
  - Connect two adaptors 1/4"F to 6 mm to filter body top 1/4" outlets.
  - Connect 1/4"F to 6 mm elbow to the bottom of the indicator (upstream - high pressure).
  - Connect 1/4"F to 6 mm adaptor to side of the indicator (downstream – low pressure).
  - Press fit the indicator to the sockets on the filter body.
  - Connect 6 mm tube length 25cm from Filter inlet port to indicator bottom (marked "+").
  - Connect 6 mm tube length 20 cm from Filter outlet port to indicator side (marked "-").
  - Hydraulic fittings may require Teflon to seal.
- Filter is ready for installation (Picture D)

### **Installation**

- Filter can be installed in vertical position or at 90° to the pipe, (Bottom of the cup pointing down or to the side).
- Ensure proper flow direction as clearly marked on the filter.
- Make sure valve 1/2" is closed.
- It is recommended to install a shut off inlet valve before the filter for maintenance.
- Filter is ready for first operation.



Picture A  
Before assembly



Picture D  
After assembly

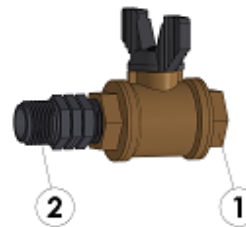

Picture B

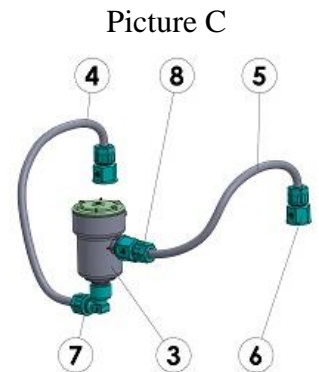

Picture C

|   |       |
|---|-------|
| A | 740mm |
| B | 645mm |
| C | 235mm |
| D | 485mm |

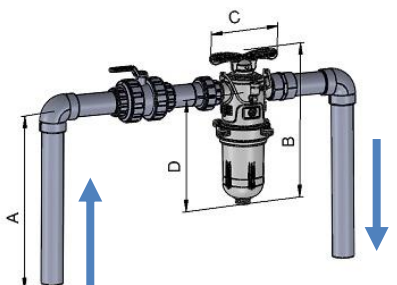

## First Operation

- Open the water source and inlet maintenance valve and check for leaks.
- Perform 2-3 flushing cycles as outlined below.
- Filter is ready for use.

## Flushing the filter

- The disc element needs to be cleaned when the head loss across the filter reaches 0.5-0.7 bar and the red pin is pushed out from the pressure indicator (Picture E).
- Turn the handle  $\frac{1}{4}+$  of a turn until the stop (Picture F).
- Wait 15–30 seconds.
- Turn the filter handle back (Picture F).
- Open the valve  $\frac{1}{2}$ " for 10 seconds and close (Picture G).

**Please note:** the strength required to turn the handle may vary according to water pressure, the water quality and its source.

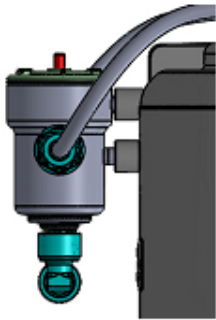

Picture E

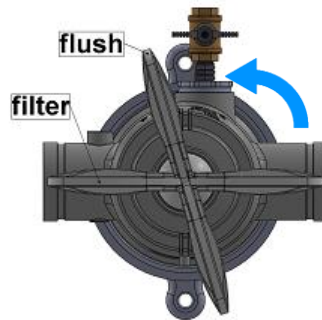

Picture F

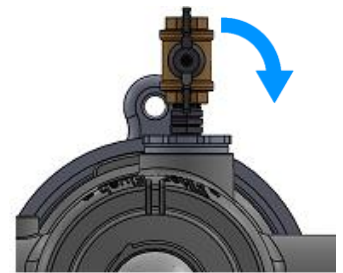

Picture G

## Periodic Maintenance 1 Action filters

### Warning:

- **Never open the filter under pressure! to release pressure turn the handle to flush position and open the flush valve 1/2"**
- **Before servicing the filter make sure it is empty of water and the inlet valve is closed.**

### Secondary flush port cleaning

- The secondary flush port should be examined every 30 days or if the flush cycle does not reduce the head loss (filter does not flush effectively).
- Disassemble the flush valve 1/2" F with nipple 1/2" (Picture H-1).
- Rotate the screen disc counterclockwise and pull out (Picture I)
- Make sure the screen is intact and has no tears
- Flush thoroughly under stream of water.
- Return the screen disc to its place and rotate clockwise until it stops.
- Assemble the nipple with the flush valve and close.

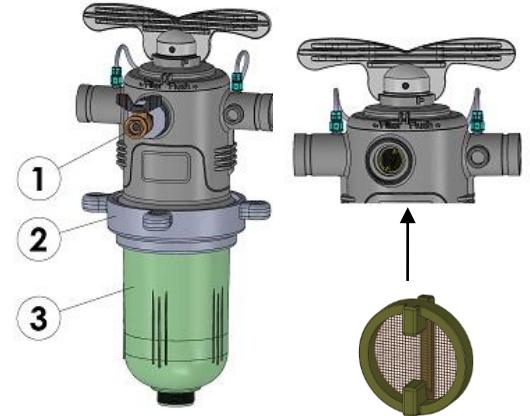

Picture I

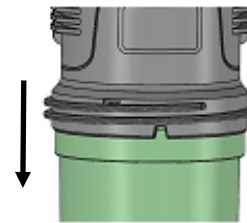

Picture H

### Discs manual cleaning

- The Discs should be cleaned manually at the beginning of the irrigation season and every 90 days thereafter or if the flush cycle does not reduce the head loss (filter does not flush effectively).
- Open the tightening ring (Picture H-2) counterclockwise pull it down and put aside.
- Release the filter cup (Picture H-3) by pulling down and nudging from side to side.
- Open the lock bolt (Picture J-4) with screwdriver and remove piston (Picture J-5) and ratchet (Picture J-6).
- Remove the O-ring carefully avoiding damage (Picture K-7).
- Remove the discs carefully (Picture K-8).
- Flush discs thoroughly under stream of water. Make sure hard adhesives are removed.
- In case the discs are still not clean perform a manual flushing with HCL solution, see instructions doc. attached.
- Return all discs to the spine – make sure you returned all of them (Picture K-8).
- Return the O-ring carefully avoiding damage (Picture K-7).
- Return the piston with ratchet and close lock bolt (Picture J-4) with screwdriver.
- Tighten the cup (Picture H-3) to the filter body and position the cup protrusion opposite the socket in the filter body. (Picture H)
- Return the locking ring (Picture H-2) to its place and tighten by hand.

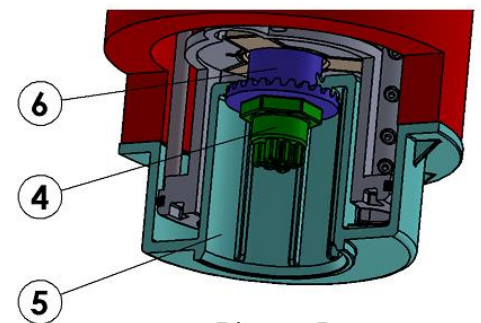

Picture J

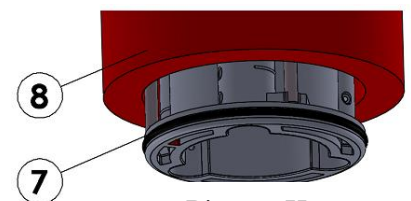

Picture K



## ADIR Semi-Automatic 3" filter TDS – Gen2 Installation and maintenance instructions 2 action

### Box contents

- Main filter assembled – picture A
- Valve 2" FF – picture L
- Valve F/F 1/2" and Nipple M/M 1/2" – picture B
- Pressure indicator kit and fittings – picture C
  - Pressure indicator (Picture C-3).
  - Tube 6 mm length 25 cm (Picture C-4).
  - Tube 6 mm length 20 cm (Picture C-5).
  - Threaded couplers 1/4"F x 2 (Picture C-6)
  - Connectors 1/4"M to 6 mm elbow x 2 (Picture C-7).
  - Connector 1/4"F to 6 mm elbow (Picture C-8).
  - Connector 1/4"F to 6 mm adaptor (Picture C-9).

### Assembly

Connect the 2" flush valve to the bottom of the filter cup, (no need to use Teflon, valve is self-seal) – Picture E Make sure handle open position is away from filter cup.

- Connect the valve 1/2" with nipple 1/2" to the flush port outlet (no need to use Teflon, valve is self-seal) – (Picture B).
- Pressure indicator kit assembly:
  - Connect two threaded couplers 1/4"F to filter body top 1/4" outlets.
  - Connect two 1/4"M to 6 mm elbow to the threaded couplers 1/4"F.
  - Connect 1/4"F to 6 mm elbow to the bottom of the indicator (upstream - high pressure).
  - Connect 1/4"F to 6 mm adaptor to side of the indicator (downstream – low pressure).
  - Press fit the indicator to the sockets on the filter body.
  - Connect 6 mm tube length 25cm from Filter inlet port to indicator bottom (marked "+").
  - Connect 6 mm tube length 20 cm from Filter outlet port to indicator side (marked "-").
  - Hydraulic fittings may require Teflon to seal.
- Filter is ready for installation (Picture D)

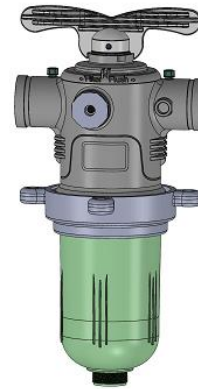

Picture A  
Before  
assembly



Picture D After  
assembly

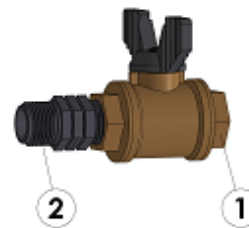

Picture B



Picture L

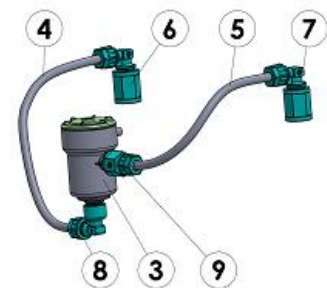

Picture C

### Installation

- Filter can be installed in vertical position or at 90° to the pipe, (Bottom of the cup pointing down or to the side).
- Ensure proper flow direction as clearly marked on the filter.
- Make sure valve 1/2" is closed.
- It is recommended to install a shut off inlet valve before the filter for maintenance.
- Filter is ready for first operation.

|   |       |
|---|-------|
| A | 950mm |
| B | 795mm |
| C | 235mm |
| D | 595mm |

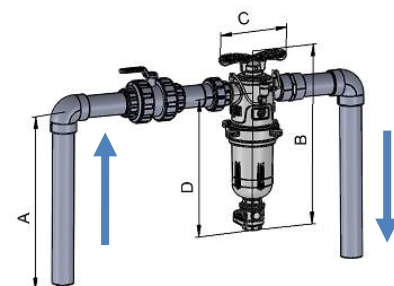

## First Operation

- Open the water source and inlet maintenance valve and check for leaks.
- Perform 2-3 flushing cycles as outlined below.
- Filter is ready for use.

## Flushing the filter

- The disc element needs to be cleaned when the head loss across the filter reaches 0.5-0.7 bar and the red pin is pushed out from the pressure indicator (Picture E).
- Open the bottom valve 2" (Picture M)
- Turn the handle ¼+ of a turn until the stop (Picture F).
- Wait 15–30 seconds.
- Turn the filter handle back (Picture F).
- Close the bottom flush valve (Picture M)
- Open the valve 1/2" for 10 seconds and close (Picture G).

**Please note:** the strength required to turn the handle may vary according to water pressure, the water quality and its source.

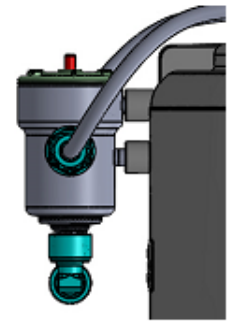

Picture E

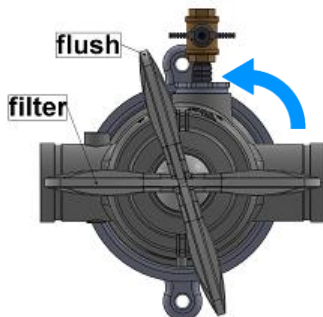

Picture F

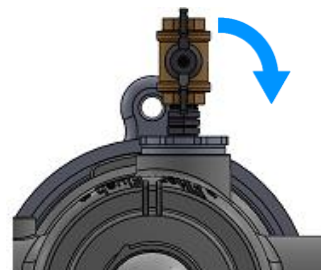

Picture G

## ADIR Semi-Automatic 2" filter TDS –Gen2 Installation and maintenance instructions 2 action

### Box contents

- Main filter assembled – picture A
- Valve 2" FF – picture L
- Valve F/F 1/2" and Nipple M/M 1/2" – picture B
- Pressure indicator kit and fittings – picture C
  - Pressure indicator (Picture C-3).
  - Tube 6 mm length 25 cm (Picture C-4).
  - Tube 6 mm length 20 cm (Picture C-5).
  - Connector 1/4"F to 6 mm adaptor x 2 (Picture C-6)
  - Connector 1/4"F to 6 mm elbow (Picture C-8).
  - Connector 1/4"F to 6 mm adaptor (Picture C-9).

### Assembly

Connect the 2" flush valve to the bottom of the filter cup, (no need to use Teflon, valve is self-seal) – Picture E Make sure handle open position is away from filter cup.

- Connect the valve 1/2" with nipple 1/2" to the flush port outlet (no need to use Teflon, valve is self-seal) – (Picture B).
- Pressure indicator kit assembly:
  - Connect two adaptors 1/4"F to 6 mm to filter body top 1/4" outlets.
  - Connect 1/4"F to 6 mm elbow to the bottom of the indicator (upstream - high pressure).
  - Connect 1/4"F to 6 mm adaptor to side of the indicator (downstream – low pressure).
  - Press fit the indicator to the sockets on the filter body.
  - Connect 6 mm tube length 25cm from Filter inlet port to indicator bottom (marked "+").
  - Connect 6 mm tube length 20 cm from Filter outlet port to indicator side (marked "-").
  - Hydraulic fittings may require Teflon to seal.
- Filter is ready for installation (Picture D)



Picture A  
Before assembly



Picture D After assembly

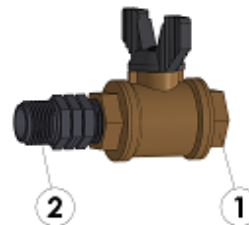

Picture B



Picture L



Picture C

### Installation

- Filter can be installed in vertical position or at 90° to the pipe, (Bottom of the cup pointing down or to the side).
- Ensure proper flow direction as clearly marked on the filter.
- Make sure valve 1/2" is closed.
- It is recommended to install a shut off inlet valve before the filter for maintenance.
- Filter is ready for first operation

|   |       |
|---|-------|
| A | 950mm |
| B | 795mm |
| C | 235mm |
| D | 595mm |

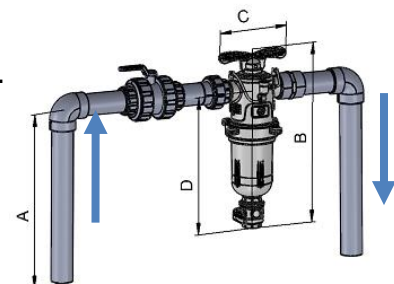

## First Operation

- Open the water source and inlet maintenance valve and check for leaks.
- Perform 2-3 flushing cycles as outlined below.
- Filter is ready for use.

## Flushing the filter

- The disc element needs to be cleaned when the head loss across the filter reaches 0.5-0.7 bar and the red pin is pushed out from the pressure indicator (Picture E).
- Open the bottom valve 2" (Picture M)
- Turn the handle 1/4+ of a turn until the stop (Picture F).
- Wait 15-30 seconds.
- Turn the filter handle back (Picture F).
- Close the bottom flush valve (Picture M)
- Open the valve 1/2" for 10 seconds and close (Picture G).

**Please note:** the strength required to turn the handle may vary according to water pressure, the water quality and its source.

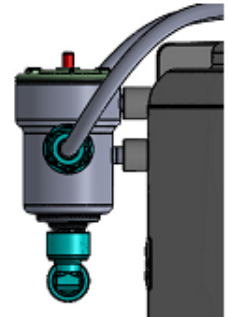

Picture E



Picture M

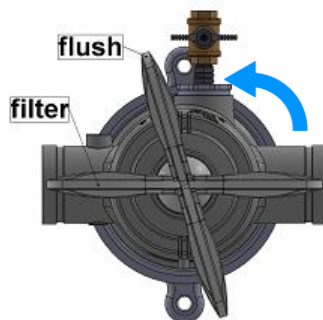

Picture F

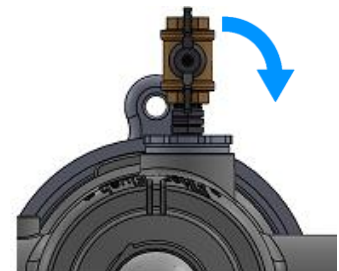

Picture G

## Periodic Maintenance 2 Action Filters

### **Warning:**

- **Never open the filter under pressure! to release pressure turn the handle to flush position and open the flush valve 1/2"**
- **Before servicing the filter make sure it is empty of water and the inlet valve is closed.**

### Secondary flush port cleaning

- The secondary flush port should be examined every 30 days or if the flush cycle does not reduce the head loss (filter does not flush effectively).
- Disassemble the flush valve 1/2" F with nipple 1/2" (Picture H-1).
- Rotate the screen disc counterclockwise and pull out (Picture I)
- Make sure the screen is intact and has no tears
- Flush thoroughly under stream of water.
- Return the screen disc to its place and rotate clockwise until it stops.
- Assemble the nipple with the flush valve and close.

### Discs manual cleaning

- The Discs should be cleaned manually at the beginning of the irrigation season and every 90 days thereafter or if the flush cycle does not reduce the head loss (filter does not flush effectively).
- Open the tightening ring (Picture H-2) counterclockwise, pull it down and put aside.
- Release the filter cup (Picture H-3) by pulling down and nudging from side to side.
- Open the lock bolt (Picture J-4) with screwdriver and remove piston (Picture J-5) and ratchet (Picture J-6).
- Remove the O-ring carefully avoiding damage (Picture K-7).
- Remove the discs carefully (Picture K-8).
- Flush discs thoroughly under stream of water. Make sure hard adhesives are removed.
- In case the discs are still not clean perform a manual flushing with HCL solution, see instructions doc. attached.
- Return all discs to the spine – make sure you returned all of them (Picture K-8).
- Return the O-ring carefully avoiding damage (Picture K-7).
- Return the piston with ratchet and close lock bolt (Picture J-4) with screwdriver.
- Tighten the cup (Picture H-3) to the filter body and position the cup protrusion opposite the socket in the filter body. (Picture H)
- Return the locking ring (Picture H-2) to its place and tighten by hand.

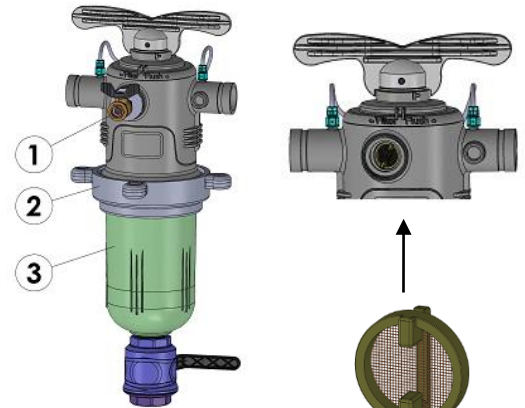

Picture I

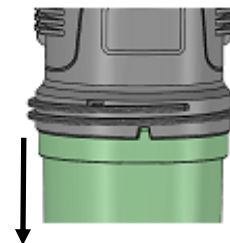

Picture H

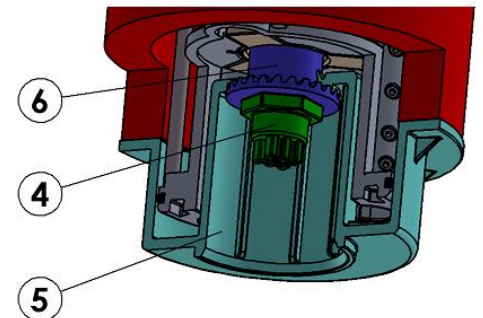

Picture J

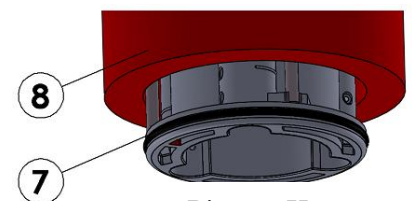

Picture K

## **Trouble shooting for all models**

- Head loss is not decreasing after flushing cycle:
  - Check that the pressure is not below 2 bar.
  - Check that there is no disturbance to the flushing flow.
  - Flush the internal screen by opening its valve 1/2".
  - Repeat the flushing cycle again, do not forget to open the filter valve 2" before turning the handle.
- Filter is still not clean:
  - Clean the internal screen: see Periodic Maintenance – Secondary flush port cleaning (outlined below)
  - Clean discs manually: see Periodic Maintenance – Discs manual cleaning (outlined below)
- Filter handle is not turning:
  - Check that the bottom valve 2" is fully open before turning the handle.
  - Check that water flows through the bottom valve 2".
  - Check that inlet pressure is lower than 6 bars.
- Filter handle is still not turning:
  - Partly close the inlet maintenance valve and turn the handle.
  - Perform a flushing cycle, do not forget to open the filter valve 2" before turning the handle.
  - Open the inlet maintenance valve.

## **TDS - Proper flushing of discs**

It is recommended to clean the discs before and after irrigation season to ensure proper functioning of the filter for many years. Manual flushing is required when the filter is clogged and flushing process does not clean it properly.

- Before opening the filter cup close the inlet valve of the system and release the pressure in the filter battery by opening the drain valve.
- Release the disc cap and when the discs are loose on the spine perform a manual flushing using a water hose to flush the discs in high pressure directing the flow tangentially to the spine.

### **Never open the filter under pressure**

- Dismantle discs from the spine.
- Visually check for twisted or worn-out discs and replace if required.
- In case of chemical deposits on discs grooves, tie each disc set with a nylon rope and soak the discs into an appropriate solution – see below. After treatment, rinse thoroughly with fresh water.
- Reassemble the discs on the spines and back in the filter, then close and tighten filter body. Ensure head loss does not exceed 2-3m.

### **Detailed explanation of chemical treatment of the discs**

Several types of deposits can clog the disc. These can be:

- Organic matter, it will be brown or green and will look like mucus.
- Metal oxide - iron in rust color or manganese in black color.
- Carbonates - white or grey in color
- Combination of several deposits.

### **Perform cleaning in a properly ventilated area and use gloves, safety glasses and protective clothes.**

#### **6.1 Preparing the solution for immersing the discs**

##### **For organic material use Sodium Hypochlorite**

- Mix 5 liters of Hypochlorite (10% concentration) with 5 liters of water. The solution is 5% concentrated.
- Tie the discs with a rope and soak in the solution for 8 hours- then rinse with water thoroughly.
- After installing the discs back in the filter perform several flushing cycles.

##### **For carbonate and iron deposits use Hydrochloric Acid.**

- Mix 2 liters of Hypochlorite (30% concentration) with 10 liters of water. The solution is 5% concentrated.
- Tie the discs with a rope and soak in the solution for 8 hours- then rinse with water thoroughly.

##### **For complex deposits**

- In case the user is not sure about the type of the deposits he should run a test.
- Put several discs in Sodium hypochlorite solution and several in a Hydrochloric Acid solution, (prepare the solution as explained above).
- If one of the solutions cleans the discs perform cleaning process in that solution.
- If none of the solutions cleaned the discs completely replace the discs that were immersed in the Hypochlorite acid into the Sodium Hypochlorite and vice versa and watch which treatment cleaned the discs. This is the process to follow with all discs.
- If none of the treatments cleaned the discs properly send several discs to a laboratory to get a diagnosis of the deposits and the proper treatment needed in order to clean them.

Step 1  
Release the filter clamp

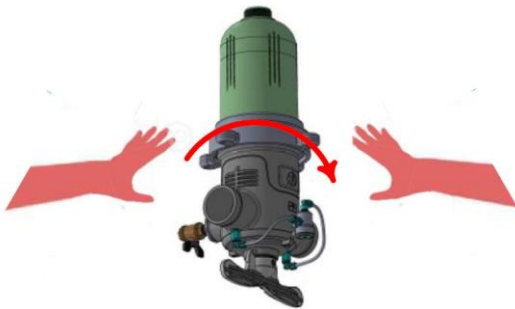

Step 2  
Remove the filter cup and then  
remove the O-ring carefully

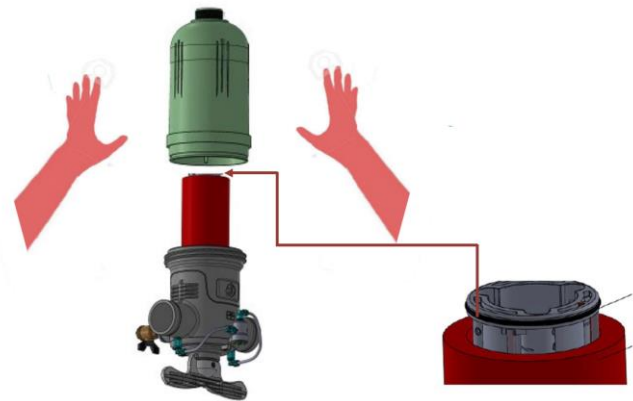

Step 3  
Remove the discs

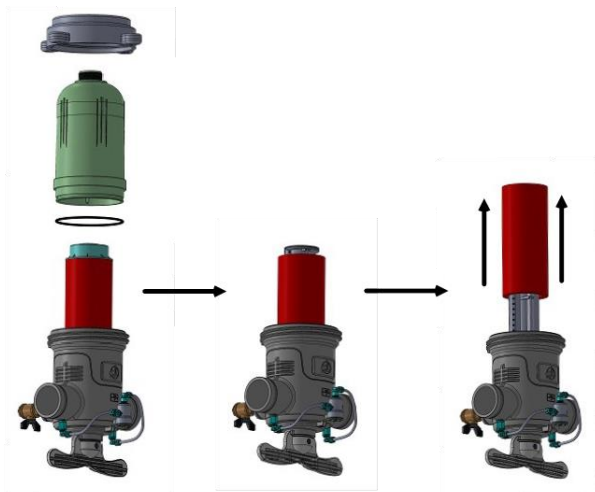

Step 4  
Place the discs in HCL solution

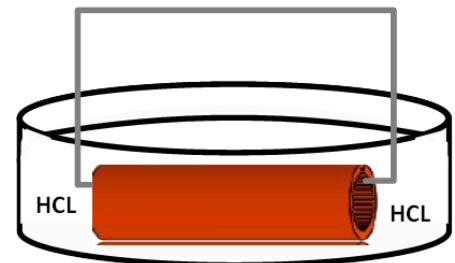



Step 5  
Reassemble the filter

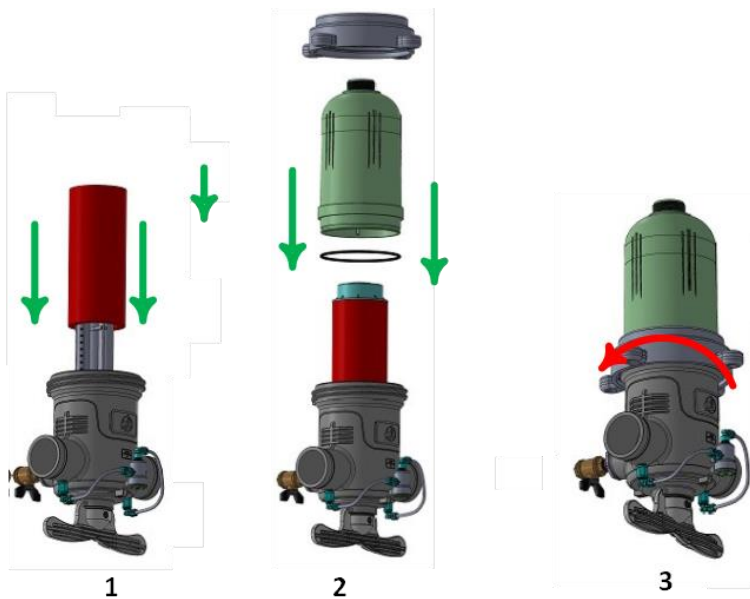

**After installing the discs back in the filter perform several flushing cycles.**

## **ADIR Semi – Automatic Disc filters battery model TDSB**

### **Installation and maintenance instructions**

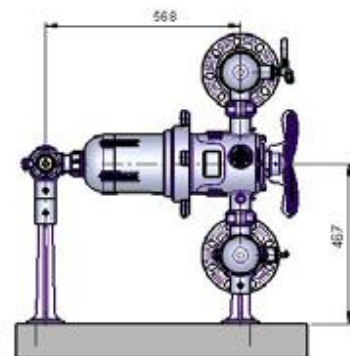
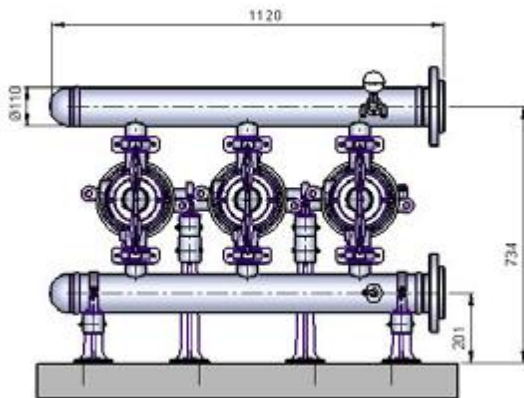
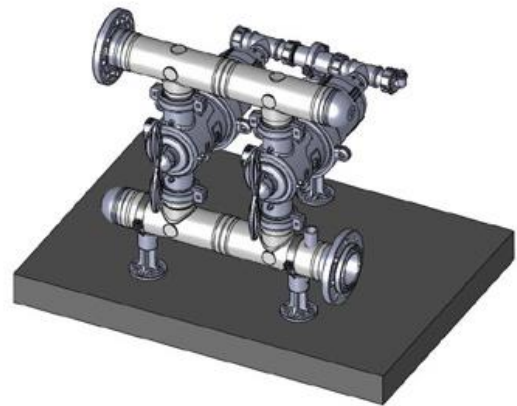
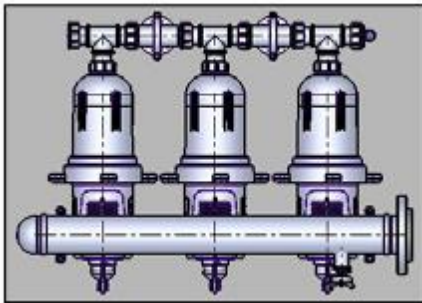

We recommend the following in order to guarantee the proper functioning of the filters:

- Pressure indicator, (supplied separately), should be connected to the designated ports.
  - Please pay attention to connect properly (indicator installed on the outlet manifold and the tube connected to the indicator).
- An air release valve should be installed at the inlet to our filtration system on the top elbow at the system inlet.
- A butterfly manual valve should be installed at the system inlet.
- In order to drain the flush water from the secondary filter, a 20 mm pipe should be connected to the 1/2" valve located at the screen flushing port of each of the filters.
  - The pipe must be at the lower end of the battery and carry the water out of the container.
  - This pipe can be connected to the drainpipe of the filters flushing.
- Drainage manifold should be connected to a 50 or 63mm PE pipe in order to carry the flushed water out of the container.
  - Pipe should no longer than 5 meters.



## **Initial operation**

- Make sure all filters drain valves are closed.
- Fill the battery gradually in order to prevent water hammer.
- Perform a flushing cycle of each filter one after the other by turning the handle 1/4 of a turn counterclockwise.
  - Flushing cycle: 10 – 15 sec.
- After the flushing turn the handle 1/4 of a turn clockwise in order to return to filtering mode.
- After the flushing cycle the indicator should show that the battery is clean.

### Operation

- When the indicator's red button pops up the user must perform a flushing cycle on all the filters in the battery.
  - Flushing is performed on each filter one after the other.
  - Filter maintenance instructions are attached.
- It is recommended to initiate a flushing cycle once a day.